

# African Swine Fever Prevention & Control



**Emergency Disease Control  
Biosecurity Programme**



African Swine Fever (ASF) can be considered one of the most feared epidemic diseases of pig production, the others being Swine Vesicular Disease (SVD), Porcine epidemic diarrhoea virus (PEDv) and Foot and Mouth Disease (FMD).

ASF is extremely dangerous due to its highly contagious characteristics, ability to be easily spread via a variety of vectors, high morbidity and mortality rates, and extreme resilience to withstand high and low temperatures. Add to this the fact that there is currently no effective treatment or vaccine available, and it is easy to understand why pig producers fear this disease.

## Stopping the spread of ASF infection.

So how can the spread of this highly contagious and devastating pig disease be prevented and controlled?

Biosecurity is the only real way of stopping its spread. It will reduce the impact on affected farms and will be a key to clinical recovery and virus elimination, especially on larger farms. Producers need to achieve the highest possible levels of biosecurity, leveraged by good buy-in and compliance from management, their staff and their suppliers.

ASF is very good at 'Hitching a ride' so it spreads easily. A high proportion of spread will be by pig transportation, and so is the first target of biosecurity. However, there are many other means of spread. All other transport is a risk, from feed to dead-haul, to service vehicles, to manure removal. Perhaps the next biggest risk is from transmission via contact with wild boar. People can also be vectors, via their clothes, on their boots and equipment, or any inanimate objects they may bring onto the unit.

The virus may persist in uncooked meat products and swill for several months, and therefore could be transmitted via contaminated pig feed, or meat products ingested. Aerial spread has been demonstrated, but only over short distances and is unlikely to be a major factor.



# Advanced biosecurity is the answer.

For biosecurity to be effective against ASF there must be good planning, good procedures, good training and good tools.

## Planning

Thoroughly review your biosecurity plans at all levels using a risk based approach involving your veterinarian, management team and farm staff.

Starting with transport, scheduling is vital; breeding herds should preferably have dedicated transport being at the top of the biosecurity pyramid. If possible, have different transport for infected and free farms.

Personnel movement is another target area, with staff sharing avoided and movement only down the pyramid. Advisers, management and field staff are all increased risks as they move more between units.

Delivery and entry of equipment needs planning, as do removal of dead pigs, manure and any other waste.

Control of wild boar/pigs, rodents and other animals should be reviewed. Ensure a secured perimeter barrier/fence is in place to stop large animals such as wild boar/pigs, deer, foxes etc. from entering the site.



Finally, in planning, there is another good rule that should be adhered to at all times; never share anything between positive or negative units, be it via transport, personnel or equipment.



## Procedures

One of the most important aspects of biosecurity is the understanding and use of lines of separation between clean and dirty areas. This has to happen throughout the production system, for example, between the loading chute and pig transporter, between the dirty and clean sides in a Danish entry system (see page 5), or between the ground and the cab of a feed delivery vehicle. All the relevant lines of separation have to be identified and correct procedures for achieving separation established and used.

There are many other procedures that need complying with. These include such things as correct use of shower facilities, correct procedures for leaving and re-entering the farm, disinfection of equipment arriving at the farm, disinfection after risk vehicles have been near the farm, and contractor and staff behaviour during manure hauling.

In an infected farm, where bio-containment is being practised, examples of procedures are: control of staff movement around the farm, cleaning and disinfection of walkways after pig movement, correct local manure removal and flushing, and high level terminal cleaning and disinfection between batches.

## Training

Buy-in and training is an integral part of any biosecurity programme. This must include management, farm staff, drivers, service personnel and visitors. They need to understand why biosecurity against ASF is important, that it is still important, and how easily the virus spreads so they can understand what they need to do.



Biosecurity coordinators must make it a prime task to train, review and retrain as needed. One challenge is high staff turnover and the need to keep up to date. Compliance is everything, and failure to comply will lead to a biosecurity breach sooner or later.

## The Tools

### Without the right tools, biosecurity will fail.

With vehicles being the number one vector through which ASF is spread, providing well equipped vehicle cleaning and disinfection areas is essential. Good vehicle washes must allow manure removal, provide good cleaning and subsequent disinfection, and vitally prevent cross contamination. The provision of drying and heating for trucks after cleaning and disinfection is an advantage, but does not replace it.



Other examples of good biosecurity tools are disinfectant arc sprays made available on approach to farms, external washes to disinfect where trucks have been, remote dead pig collection, and good entry facilities such as showers or a Danish entry system.

Some of the most important tools for effective biosecurity are the suitable LANXESS heavy duty cleaners and Virkon® disinfectants for use in the advanced biosecurity cleaning and disinfection programme.

Washing with water alone reduces contamination by up-to 60%, but using a heavy-duty detergent decreases the original organic burden by 99%. Therefore, thorough washing of all surfaces and equipment with a suitable LANXESS heavy duty cleaner is essential to achieve the best results from any subsequent disinfection procedure.

The choice of disinfectant is vital. It needs to be active against ASF but also have a broad spectrum of activity against other pig pathogens because we still need to control them. Virkon® S has an independently tested broad spectrum of activity.

Virkon® S has been proven effective against ASF at a dilution rate of 1:800 in the presence of a 1% organic serum load and at a temperature of 4°C reflecting its proven performance and suitability for real world 'on farm' conditions (test results available).

Unlike some other disinfectant chemistries, Virkon® S maintains efficacy against the ASF virus in cold farm conditions. In addition, adding liquid Propylene Glycol to Virkon® S solutions may reduce its freezing point to -10°C, without affecting efficacy, providing farmers with the reassurance that the disinfectant solution they're using will remain in solution during freezing winter conditions.

The outstanding scientifically formulated properties of Virkon® S make it the disinfectant of choice in an ASF advanced biosecurity programme at all levels from the farrowing house, transport and through to the slaughter plant.

The Danish Entry System is a good example of an easy to use biosecurity tool that can greatly help reduce the spread of disease-causing organisms such as African Swine Fever (ASF) from being introduced to, or spreading from, a pig shed/barn.

### The key to the Danish Entry System:

- a biosecure entrance to the pig shed/barn
  - the entrance area of the shed/barn has separate clean and dirty areas divided by a physical barrier, usually a small dwarf wall
  - upon entry to the building you will be in the “dirty” area where you will be required to:
    - disinfect footwear using a disinfection boot dip
    - remove outer clothing and footwear
  - wash and disinfect hands
  - move to the clean area, on the other side of the barrier, where clean protective clothing, such as boots and coveralls, are provided (boots should be put on before coveralls)
  - Disinfect boots using the disinfectant boot dip provided, and then enter the production area
- The protocol is completed in reverse when exiting the building.

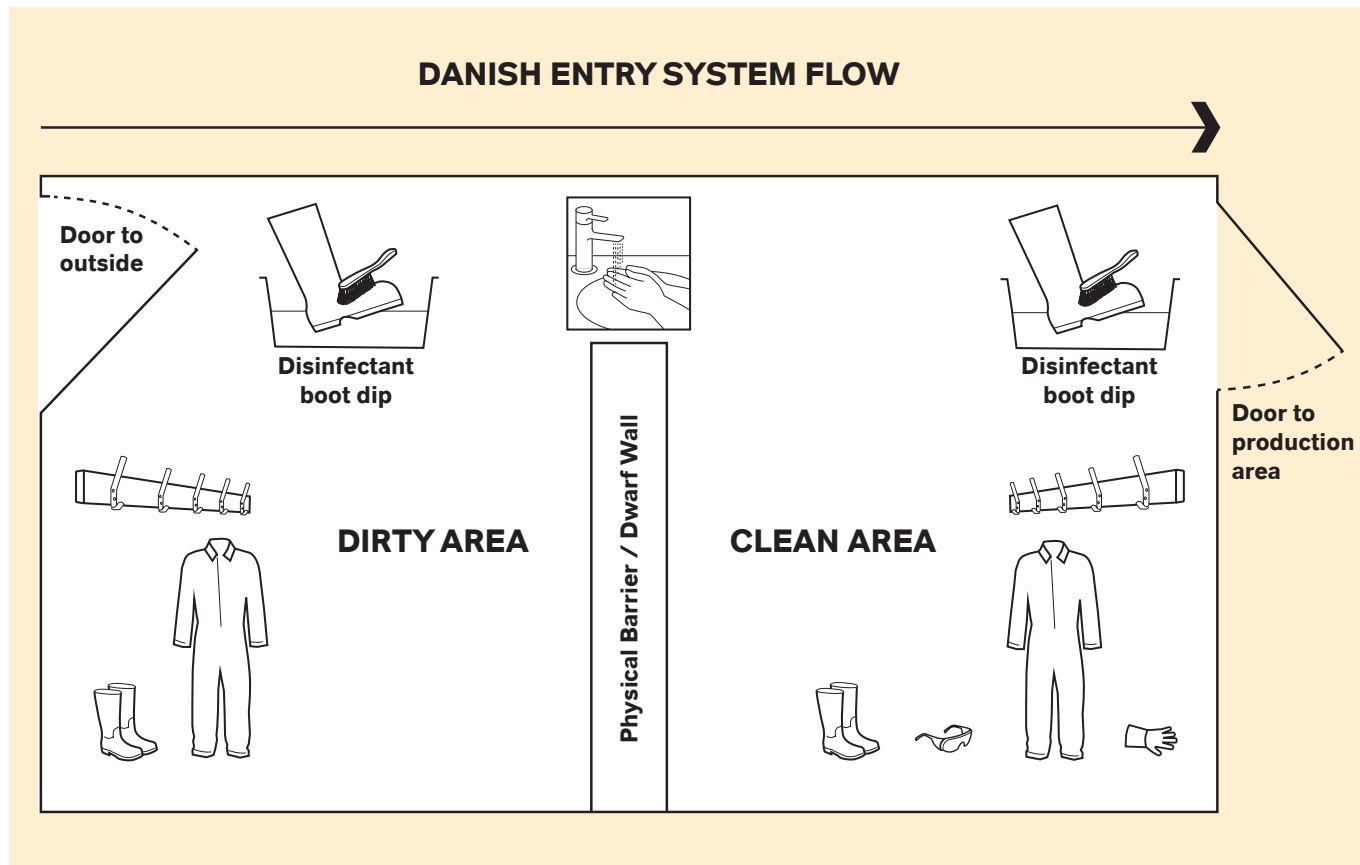

# Practical 'how to' biosecurity guide

In the face of challenging farm conditions, such as heavy organic challenge, short contact time, possible dilution by rain water, low temperatures and the broad range of disease-causing organisms that can exist on farms, Virkon® S is recommended for use at a dilution of 1:100 for Emergency Disease Control (EDC), preventative and continuous biosecurity measures to provide high levels of efficacy.



## How to make a ready-to-use Virkon® S disinfectant solution

### Preparing the solution

#### STEP 1

Site specific personal protective equipment required

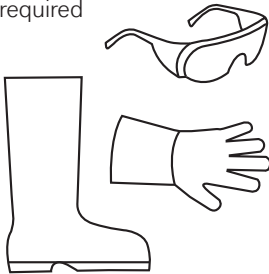

#### STEP 2

Pour 1000 litres of water

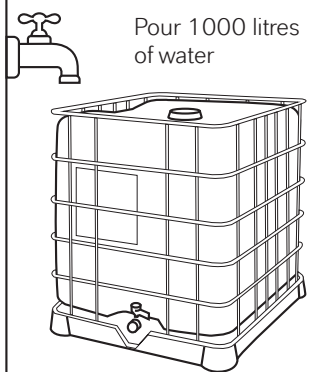

#### STEP 3

Add Virkon® S  
10kg per 1000 litres = 1:100 (1%)  
5kg per 1000 litres = 1:200 (0.5%)

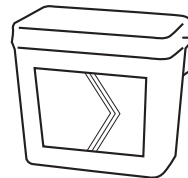

#### STEP 4

Stir thoroughly until fully dissolved, then use



## How to make a ready-to-use LANXESS heavy duty cleaner solution

### Preparing and handling the solution

#### STEP 1

Site specific personal protective equipment required

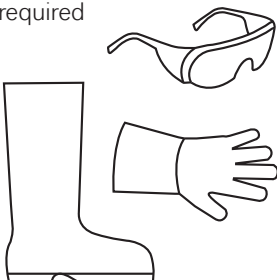

#### STEP 2

Select a 1% (1:100) diaphragm washer and insert it into your pressure washer or pump's liquid proportioner pick-up tube

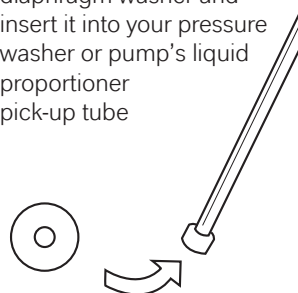

#### STEP 3

Insert proportioner pick-up tube into a suitable LANXESS heavy duty cleaner container



#### STEP 4

Commence detergent cleaning procedure



# How to clean and disinfect pig transport vehicles

## Dry Cleaning

### STEP 1

Wear appropriate personal protective equipment (coveralls, personal protective eye wear, boots and gloves)

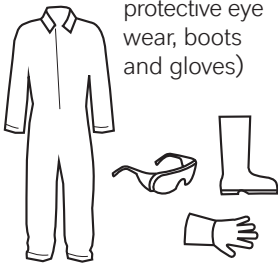

### STEP 2

Starting on top deck, scrape and brush the sidewalls, division gates and floor of the trailer



### STEP 3

Scrape/brush the tail lift of the trailer



### STEP 4

Remove any deposits of mud, straw etc. from wheels, wheel arches, mudguards and exposed chassis

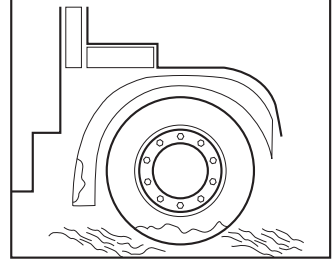

## Detergent Wash & High Pressure Rinse

### STEP 1

Soak all external surfaces with a suitable LANXESS heavy duty cleaner solution

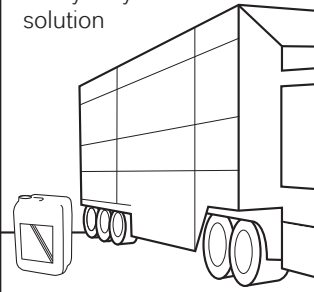

### STEP 2

Clean the outside from top down, with attention to wheels, arches and mudguards



### STEP 3

Inside, soak the ceiling, sidewalls, division gates and floor of top and bottom decks

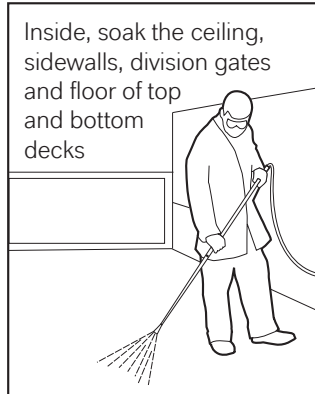

### STEP 4

Wash the tail lift and gates thoroughly



### STEP 5

Wash all vehicle equipment, tools and the belly box

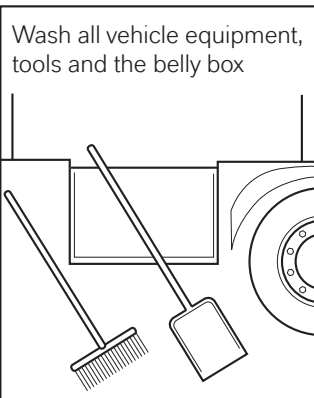

### STEP 6

Leave detergent solution for at least 20 minutes in order to penetrate and lift caked on dirt

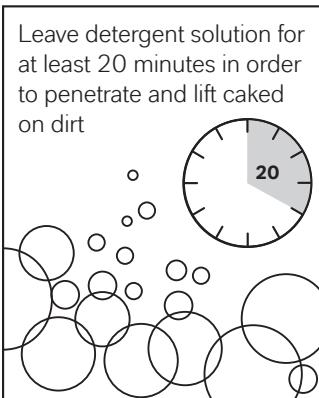

### STEP 7

Rinse all surfaces and equipment at high pressure with clean water



### STEP 8

Inspect all internal and external surfaces to ensure they are thoroughly clean

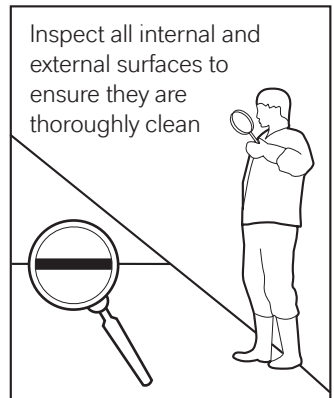

## Disinfection

### STEP 1

Wear appropriate personal protective equipment (coveralls, personal protective eye wear, boots and gloves)

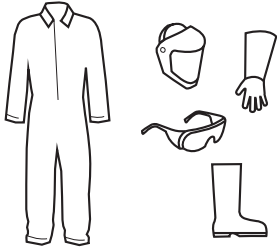

### STEP 2

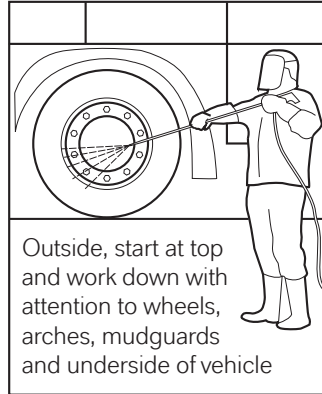

Outside, start at top and work down with attention to wheels, arches, mudguards and underside of vehicle

### STEP 3

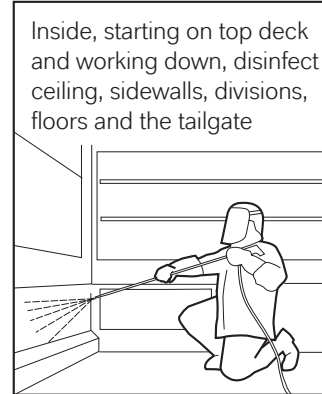

Inside, starting on top deck and working down, disinfect ceiling, sidewalls, divisions, floors and the tailgate

### STEP 4

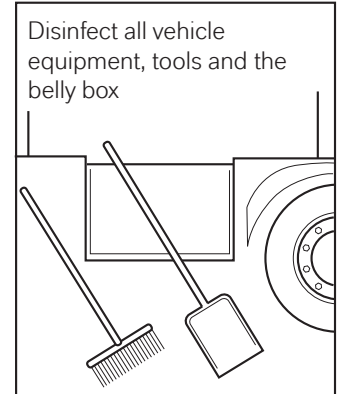

Disinfect all vehicle equipment, tools and the belly box

## Cab disinfection and final steps

### STEP 1

Remove mats and brush debris & organic matter into a refuse sack for disposal

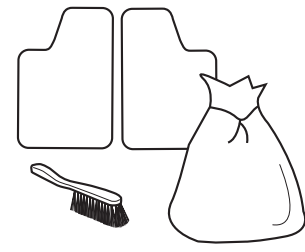

### STEP 2

Wash the cab floor, mats and vehicle pedals



### STEP 3

Using a clean cloth soaked in disinfectant solution, disinfect cab floor, mats and floor pedals

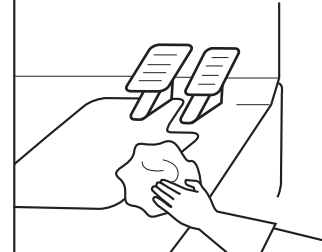

### STEP 4

Park vehicle on a slope to drain and dry

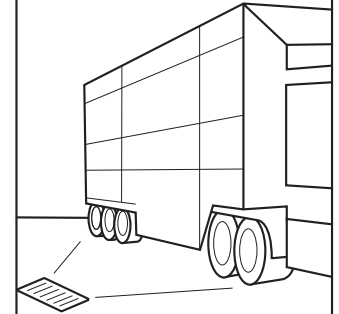

### STEP 5

Once the vehicle has been removed, wash away any remaining debris from the area



### STEP 6

Disinfect coveralls and boots

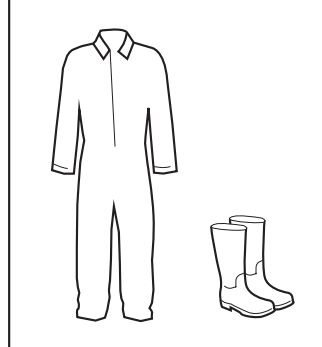

## PRODUCT DILUTION RATE

Biosecurity Task	LANXESS Product	Dilution Rate
Detergent Wash	A suitable LANXESS heavy duty cleaner	1:100 (10ml to 1 litre of water)
Surface & Equipment Disinfection	Virkon® S	1:200 (5 grams of Virkon® S to every 1 litre of water)





## How to make a Virkon® S disinfectant boot dip

### Preparing the solution

#### STEP 1

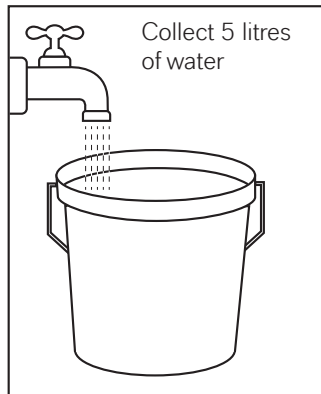

#### STEP 2

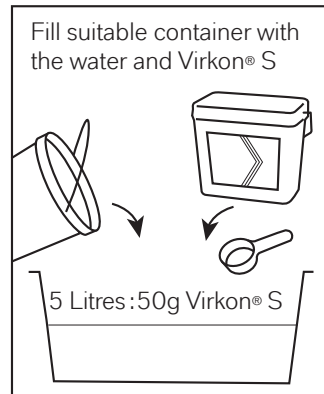

#### STEP 3

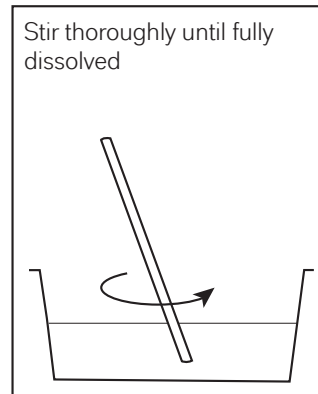

#### STEP 4



### How to use a Virkon® S disinfectant boot dip

#### STEP 1



#### STEP 2

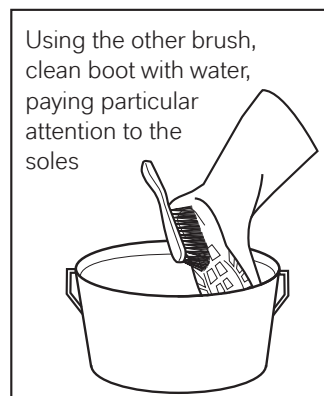

#### STEP 3



#### STEP 4



## How to clean and disinfect farm building internal and external surfaces

### Dry & wet clean procedure

#### STEP 1



#### STEP 2

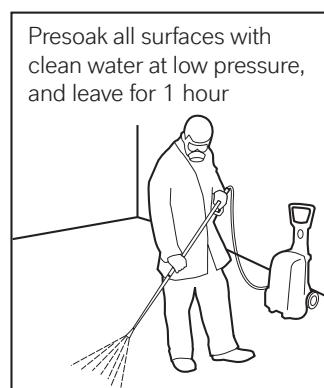

#### STEP 3

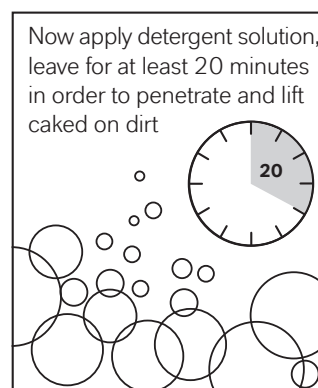

#### STEP 4



## Disinfection procedure

### STEP 1

Disinfect all internal surfaces and equipment

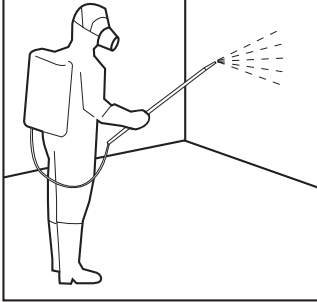

### STEP 2

Disinfect around the building including paths, roads and service areas



### STEP 3

Fog or wet mist the building with disinfectant

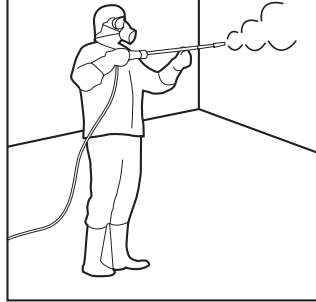

## General Perimeter & Personnel Biosecurity

### STEP 1

Restrict access to site



### STEP 2

Implement a shower in on entrance, and a shower out leaving farm policy

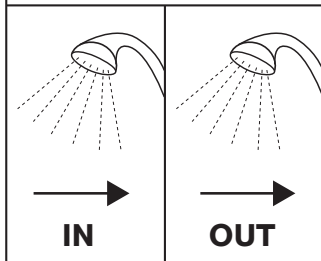

### STEP 3

Site specific personal protective equipment required

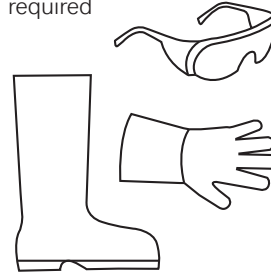

### STEP 4

Boot dip - disinfect specialised footwear

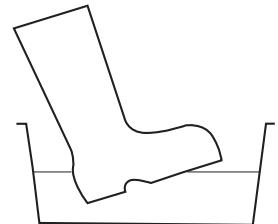

### STEP 5

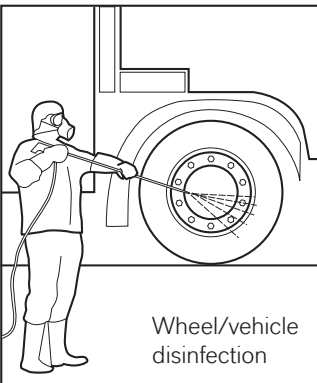

Wheel/vehicle disinfection

### STEP 6

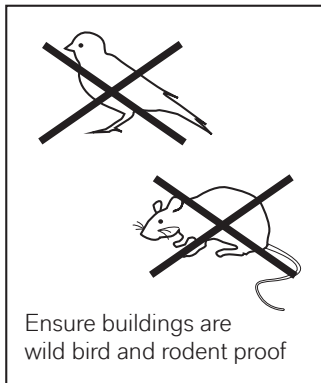

Ensure buildings are wild bird and rodent proof

### STEP 7

Erect fencing around pig production unit to keep out wild boars

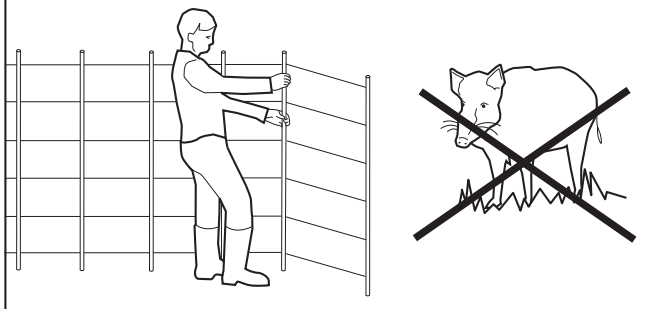

# Virkon® S Application & Use Guidance

## Surface and Equipment Disinfection

Surface Disinfection	Dilution Rate	Application
Routine disinfection for all surfaces, earth, wood, and concrete	1:100 (10 grams of Virkon® S to every 1 litre of water)	Using a pressure washer or other mechanical sprayer, apply Virkon® S solution at an application rate of 300ml/m <sup>2</sup> .

## Surface Application Usage Chart

To estimate the total surface area to be disinfected, including walls and ceilings, multiply the total floor area by 2.5.\*

Surface Area to be Disinfected	Volume of Water Required	Dilution Rate	
		1:100 (1%)	1:200 (0.5%)
		Quantity of Virkon® S to be added	
50m <sup>2</sup>	15 litres	150g	75g
100m <sup>2</sup>	30 litres	300g	150g
500m <sup>2</sup>	150 litres	1.5kg	750g
1000m <sup>2</sup>	300 litres	3kg	1.5kg
2500m <sup>2</sup>	750 litres	7.5kg	3.75kg

1. Decide on the volume of disinfectant solution required at the appropriate dilution rate.
2. Measure out the appropriate quantity of Virkon® S powder to achieve the desired dilution rate.
3. Add the Virkon® S powder to the water and stir thoroughly to dissolve.
4. Using a pressure washer or other mechanical sprayer, apply Virkon® S solution at an application rate of 300ml/m<sup>2</sup>.
5. All surfaces should be cleaned and allowed to dry prior to disinfection.

\*This calculation is a guide based upon typical UK conversion rates, and reflects usage in buildings with semi porous surfaces. Please check your country-/regional-specific requirements.

## Equipment Disinfection

Equipment Disinfection	Dilution Rate	Application
Routine cleaning and disinfection of movable equipment	1:100 (10 grams of Virkon® S to every 1 litre of water)	Using a brush or pressure washer, wash all equipment in Virkon® S solution until visibly clean.

## Water System Disinfectant

Terminal and continuous disinfection — all water systems can potentially contain some viral and bacterial contamination, especially header tanks where dust and debris can accumulate. Disinfection will clean the system and eliminate viruses, bacteria, and fungal growth.

Water System Disinfection	Dilution Rate	Application
Terminal disinfection	1:200 to 1:100	Isolate header tank at the mains and drain off to drinker points farthest from tank. Clean out any gross soiling and debris. Refill with water and add the appropriate volume of Virkon® S powder, thoroughly stir and leave for 10 minutes. Flush system through to all drain-off points and leave for a further 50 minutes before draining system and refilling with clean water.  At the terminal disinfection stage, biofilm build-up within drinking water lines is a known issue of concern, we recommend a longer contact time to address this challenge. Follow the instructions as above, but increase the soak time to a minimum of 4 hours.
Continuous disinfection	1:1000	Dose header tank as required, or apply through suitable water system dosing equipment.

## Virkon® S Water Disinfection Usage Table

Litres of Water to be Disinfected	Dilution Rate		
	Routine Terminal 1:200	High Disease Risk Terminal 1:100	Continuous Water Disinfection 1:1000
	Quantity of Virkon® S to be added		
100 litres	500g	1 kg	100g
250 litres	1.25kg	2.5kg	250g
500 litres	2.5kg	5kg	500g
1000 litres	5kg	10kg	1 kg



## Aerial Disinfection

### Misting/Aerial Spraying, Cold and Thermal Fogging

To assist the control of organisms that may be introduced into a building during the set up procedure, and to disinfect inaccessible areas of the building and the air, use either a fine mist sprayer or thermal fogging machine to apply Virkon® S disinfectant solution evenly. Aerial disinfection may also help control any contamination introduced to the building surfaces by airborne particulate matter present within the environment.

Equipment Disinfection	Dilution Rate	Application
Misting / Aerial Spray	1:200	Using either a pressure washer or knapsack sprayer on its finest mist setting, apply 20ml of Virkon® S solution per m <sup>3</sup> of air space.*
Cold Fogging	1:100	Use a mechanical mister to apply the Virkon® S solution at a rate of 40ml per m <sup>3</sup> of air space.
Thermal Fogging	1:25 (4%) solution of Virkon® S in an 90:10 water: Virkon® S Fog Enhancer mixture	Using a suitable thermal fogging machine, apply the prepared solution at 10ml per m <sup>3</sup> of air space.

\* Equivalent to approximately 1 litre of Virkon® S solution per 20m<sup>2</sup> of floor space. The calculations in this table are a guide based upon typical UK conversion rates, and reflects usage in buildings with semi-porous surfaces. Please check your country/regional specific requirements.

### Aerial Disinfection in the Presence of Livestock

- Virkon® S can be misted in the presence of pigs at a dilution rate of 1:200 (0.5%)
- A cold fogger or mister should be used\*.
- Always read the Virkon® S label to ensure regulatory compliance.



\* (allowing droplet sizes >35 micron)

# DeterUltra®

Superior Heavy Duty  
High-Density Foaming Cleaner



LONG LASTING  
HIGH-DENSITY  
FOAM



SUPERIOR  
DETERGENCY  
ACTION



SAVES TIME  
AND WATER  
on cleaning operations



DEEP CLEANS  
surfaces to optimise  
disinfection



HIGHLY EFFICIENT  
hard water  
performance

## Applications

DeterUltra® can be used to clean a wide range of equipment and hard surfaces including metal, wood, plastic, concrete, feeders, drinkers, etc.

## Composition

A synergistic blend of highly alkaline anionic and non-ionic surfactants in an aqueous solution incorporating sodium hydroxide, complexing agents and solvents to produce a superior foaming adherence and optimum detergency performance.

## General Properties

DeterUltra® is a powerful stabilised high-foaming alkaline cleaning concentrate which offers:

- Premium cleaning and degreasing properties
- Enhanced high-density long lasting foam
- Free from colourants and fragrances
- Good materials compatibility
- Suitable for use in hard water conditions

# DeterBio®

Powerful Alkaline Cleaner



EXCELLENT FOAM  
ADHERENCE  
on surfaces



POWERFUL  
DETERGENCY  
ACTION



APPROVED  
FOR ORGANIC  
FARMING



SAVES TIME  
AND WATER  
on cleaning operations



DEEP CLEANS  
surfaces to optimise  
disinfection

## Applications

DeterBio® can be used to clean equipment and hard surfaces including metal, wood, plastic, concrete, feeders, drinkers etc.

## Composition

A synergistic blend of anionic and non-ionic surfactants in an aqueous solution incorporating sodium hydroxide, solvent and sequestrant sq. excipients.

## General Properties

The powerful formulation of DeterBio® is an alkaline cleaning concentrate which offers:

- Powerful cleaning and degreasing properties
- Excellent foam adherence to surfaces and equipment
- Approval for use in organic farming environments
- Good materials compatibility
- Free from colourants and fragrances

# DeterKlyn®

General Multipurpose Foaming Cleaner



HIGH FOAMING  
FORMULATION



EXCELLENT  
CLEANING ACTION



SAVES TIME  
AND WATER  
on cleaning operations



DEEP CLEANS  
surfaces to optimise  
disinfection



HIGHLY EFFICIENT  
hard water  
performance

## Applications

DeterKlyn® can be used as a general multipurpose detergent to clean farm equipment and hard surfaces including metal, wood, plastic, concrete.

## Composition

A formulated blend of anionic and non-ionic surfactants in an aqueous solution incorporating complexing solvent agents.

## General Properties

DeterKlyn® is an alkaline cleaning concentrate which offers:

- An effective cleaning action
- A lasting foam on surfaces and equipment
- Suitable for use in hard water conditions
- Good materials compatibility
- Free from colourants and fragrances



# Virkon® S

**Powerful Broad Spectrum  
Virucidal Disinfectant**



Virkon® S is a scientific breakthrough with performance characteristics that have defined biosecurity standards. Not surprisingly, Virkon® S is the choice of the Food and Agriculture Organization of the United Nations and governments worldwide to secure biosecurity and strengthen emergency disease control (EDC) contingency planning. The Australian and New Zealand governments' AUSVETPLAN is probably the best regarded EDC reference source. Virkon® S continues to be the only branded disinfectant referred to in the 2008 AUSVETPLAN, stating that "Virkon® S is a modern disinfectant with outstanding virucidal properties."

## **It is proven:**

-  To kill over 500 strains of viruses, bacteria, and fungi
-  Active against pathogens responsible for Foot and Mouth Disease (FMD), Porcine Reproductive and Respiratory Syndrome (PRRS), Porcine Circovirus type2 (PCV2), Porcine Epidemic Diarrhoea virus (PEDv), African Swine Fever (ASF) plus *Salmonella*, *Campylobacter* and *E. coli*
-  To be powerful, fast acting, flexible, multipurpose biosecurity disinfectant



## The gold standard boot dip disinfectant – for rapid speed of kill.

Independent field trials have demonstrated the impracticality of many types of disinfectants for boot dips due to slow kill rates. Researchers at Indiana's Purdue University in the US compared the performance of disinfectants from six leading classes,<sup>1</sup> and only the QAC disinfectant provided adequate boot dip disinfection but required an impractical five-minute soak after boot cleaning. However, when Virkon® S was evaluated under similar circumstances, effective disinfection was achieved after boot cleaning in just 30 seconds.<sup>2</sup> The study confirmed that Virkon® S achieves excellent speed of kill at low temperatures and in the presence of organic challenge.



## Aerial misting in the presence of animals.

Spraying a fine disinfectant mist in swine housing can help reduce cross infection and prevent secondary infection during outbreaks of respiratory and other diseases. Virkon® S can be misted in the presence of pigs at a dilution rate of 1:200 (0.5%). It is always important to read the Virkon® S label in order to ensure regulatory compliance.



## Biosecurity in a single pack.

Virkon® S offers farmers a convenient, multipurpose biosecurity system all in one pack for a wide range of applications:

- Surfaces
- Equipment
- Vehicles
- Aerial Disinfection
- Water Delivery Systems





# Proven Broad Spectrum Efficacy.

## Virucidal Activity Data

Pig Disease / Related Condition	Virus Family	Dilution Rate	Contact time (mins)
African Swine Fever (ASF) Strain Ba71V	<i>Asfarviridae</i>	1:100	15 seconds
		1:200	30 seconds
		1:500	5
		1:800	10
		1:1000	60
African Swine Fever Netherlands '86 isolate	<i>Asfarviridae</i>	1:250	30
African Swine Fever LIL20/1 isolate	<i>Asfarviridae</i>	1:800	30
Aujeszky's disease (AD)	<i>Herpesviridae</i>	1:100	1
Classical Swine Fever (CSF)/Hog Cholera	<i>Flaviviridae</i>	1:150	30
Foot and Mouth Disease (FMD) (DEFRA approval) Foot and Mouth Disease (FMD)	<i>Picornaviridae</i>	1:1300	30
		1:200	1
Porcine epidemic diarrhoea (PED) Porcine epidemic diarrhoea (PED)	<i>Coronaviridae</i>	1:600	10
		1:200	1
Porcine Reproductive and Respiratory Syndrome (PRRS)	<i>Arterivirus</i>	1:600	10
		1:200	1
Porcine Rotavirus	<i>Reoviridae</i>	1:600	10
Post Weaning Multisystemic Wasting Syndrome (PMWS) Porcine Dermatitis and Necroathy Syndrome (PDNS) Porcine Circovirus type 2 (PCV2)	<i>Circoviridae</i>	1:200	10
Seneca Valley virus (SVV)	<i>Picornaviridae</i>	1:105	10
Swine Influenza (SI) H1N1	<i>Orthomyxoviridae</i>	1:200	1
Swine Vesicular Disease (SVD) (DEFRA approval)	<i>Picornaviridae</i>	1:100	30
Transmissible Gastroenteritis (TGE)	<i>Coronaviridae</i>	1:100	10
Vesicular Stomatitis (VS)	<i>Rhabdoviridae</i>	1:200	10

## Fungicidal Activity Data

Pig Disease / Related Condition	Pathogen	Dilution Rate	Contact time (mins)
Aspergillosis	<i>Aspergillus niger</i>	1:25	30
Dermatophytosis	<i>Trichophyton mentagrophytes</i>	1:50	10
Dermatophytosis	<i>Trichophyton interdigitale</i>	1:67	30
Gastro-oesophageal ulcers	<i>Candida albicans</i>	1:100	10

## Bactericidal Activity Data

Pig Disease / Related Condition	Pathogen	Dilution Rate	Contact time (mins)
Abortions	<i>Brucella abortus</i>	1:100	10
Abortion, foetal loss, endometritis, mastitis	<i>Klebsiella pneumoniae</i>	1:100	10
Abortion septicaemia, encephalitis, food poisoning — humans	<i>Listeria monocytogenes</i>	1:100	10
Atrophic Rhinitis	<i>Bordetella bronchiseptica</i>	1:100	10
Botryomycosis	<i>Staphylococcus aureus</i>	1:100	0.5
Dermatitis	<i>Dermatophilus congolensis</i>	1:100	10
Diarrhoea, oedema	<i>Escherichia coli</i>	1:200	5
Enterocolitis, septicaemia, food poisoning — humans	<i>Salmonella typhimurium</i> DT104	1:200	30
Enzootic pneumoniae	<i>Mycoplasma hyopneumoniae</i>	1:200	1
Food poisoning — humans	<i>Bacillus cereus</i>	1:100	10
Food poisoning — humans	<i>Campylobacter coli</i>	1:100	5
	<i>Campylobacter jejuni</i>	1:100	5
	<i>Campylobacter jejuni</i>	1:200	30
	<i>Campylobacter pyloridis</i>	1:100	10
Food poisoning — humans	<i>Escherichia coli</i> O157:H7	1:100	5
Food poisoning — humans	<i>Salmonella choleraesuis</i>	1:100	10
	<i>Salmonella enteritidis</i> PT4	1:100	5
	<i>Salmonella enteritidis</i>	1:200	30
	<i>Salmonella hadar</i>	1:200	30
	<i>Salmonella infantis</i>	1:200	30
	<i>Salmonella thomasville</i>	1:200	30
	<i>Salmonella virchow</i>	1:200	30
Greasy pig disease	<i>Staphylococcus hyicus</i>	1:100	10
	<i>Staphylococcus hyicus</i>	1:200	30
Human infections	<i>Staphylococcus aureus</i> (pig MRSA)	1:100	30
Necrotizing enterocolitis	<i>Clostridium perfringens</i>	1:100	10
Pneumonia, Atrophic Rhinitis	<i>Pasteurella multocida</i>	1:100	10
Polyserositis	<i>Mycoplasma hyorhinis</i>	1:800	5
Porcine Pleuropneumonia	<i>Actinobacillus pleuropneumoniae</i> ( <i>Haemophilus pleuropneumoniae</i> )	1:200	5
Respiratory infection	<i>Pseudomonas aeruginosa</i>	1:200	5
Secondary infections, co-infections with PCV2	<i>Proteus mirabilis</i>	1:100	5
Swine erysipelas	<i>Erysipelothrix rhusiopathiae</i>	1:100	10
Septicaemia, meningitis, arthritis, bronchopneumonia	<i>Streptococcus suis</i>	1:400	30
Septicaemia, respiratory disease	<i>Haemophilus somnus</i>	1:100	10
Swine dysentery	<i>Brachyspira hyodysenteriae</i>	1:3333	10
Swine proliferative enteritis	<i>Lawsonia intracellularis</i>	1:100	30
Swine enteritis related infections	<i>Pasteurella haemolytica</i>	1:100	10
Various infections — humans	<i>E.coli</i> ESBL strain	1:100	10
Various infections — humans	<i>Klebsiella pneumoniae</i> ESBL strain	1:100	10

The specified uses and registered claims for Virkon® S may vary from country to country. Please contact LANXESS directly to verify country-specific approved usages. See next page for contact details.

# References

1. Amass SF et al. *Evaluating the efficacy of boot baths in biosecurity protocols*. J Swine Health Prod 2000; 8:169–173.
2. Amass SF et al. *Evaluation of the efficacy of a peroxygen compound, Virkon® S, as a boot-bath disinfectant*. J Swine Health Prod 2001;9(3):121–123.



Antec International Limited  
LANXESS Material Protection Products  
Windham Road, Chilton Industrial Estate,  
Sudbury, Suffolk, CO10 2XD  
United Kingdom

Tel. +44 (0)1787 377305  
biosecurity@lanxess.com  
biosecuritysolutions.lanxess.com  
lanxess.com

This information and our technical advice – whether verbal, in writing or by way of trials – is subject to change without notice and given in good faith but without warranty or guarantee, express or implied, and this also applies where proprietary rights of third parties are involved. Our advice does not release you from the obligation to verify the information currently provided - especially that contained in our safety data and technical information sheets - and to test our products as to their suitability for the intended processes and uses. The application, use and processing of our products and the products manufactured by you on the basis of our technical advice are beyond our control and, therefore, entirely your own responsibility. Our products are sold in accordance with the current version of our General Conditions of Sale and Delivery.

The specified uses and registered claims for the product may vary from country to country. Please contact LANXESS to verify country-specific approved uses.

**Use biocides safely. Always read the label and product information before use.**



Powerful Broad Spectrum  
Virucidal Disinfectant



# 10 reasons to put Virkon® S at the heart of pig farm biosecurity.

1. Virkon® S redefined farm biosecurity and leads the way forward in emergency disease control measures
2. Approved by governments worldwide to combat major diseases, such as African Swine Fever, FMD, PRRS virus, PED and more
3. The only branded disinfectant referred to in the 2008 AUSVETPLAN, Australia and New Zealand's emergency disease control plan
4. The gold standard boot dip disinfectant that kills pathogens 10 times faster than the nearest competitor, even at low temperatures and in the presence of organic challenge<sup>1</sup>
5. Independently proven in field trials to be highly effective against the most serious threat to livestock: viruses
6. No need to rotate; proven to reduce the potential infectivity of resistant *Salmonella* superstrains
7. Superior operator safety profile; can be misted in the presence of animals
8. Formulated to include ingredients that have been carefully selected for their ability to degrade naturally within the environment
9. Easy to store and to transport by rail, sea, and air, with no additional spend requirements for storage or transport
10. Biosecurity in a single pack for surfaces, equipment, vehicles, aerial disinfection, and water delivery systems

©2023 LANXESS. Virkon®, LANXESS, the LANXESS Logo and any associated logos are trademarks or copyrights of LANXESS Deutschland GmbH or its affiliates. All trademarks are registered in many countries worldwide.

Learn more at [virkon.com](https://virkon.com)

